

# Installation Guide

## UB-QX300

### 3 Piece U-Bracket Speaker Mount

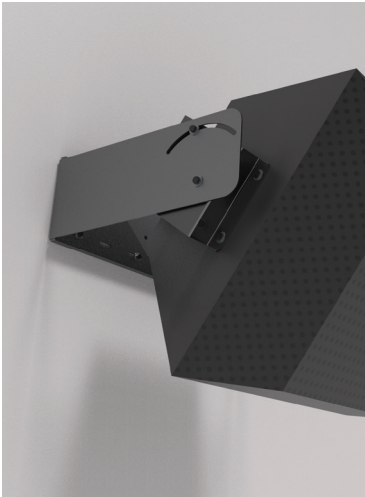

The UB-QX300 Three-piece U-Bracket kit is designed to mount and aim the EAW QX-300 series speakers, to walls, decks, ceilings and under balconies.

#### Contents:

Be sure that all of the following items are included in this kit before proceeding:

1 pc	U-Bracket	10 pcs	3/8-16 x 1.5" Hex Cap
2 pcs	Side Mounting Bracket	10 pcs	3/8" Flat Washer
2 pcs	3/8 IDx3ODx1/8 Neo-Washer	10 pcs	3/8" Split Washer
1 pc	Instruction Sheet		
2 pcs	1/2 IDx1.06OD x.13 neo-washer		

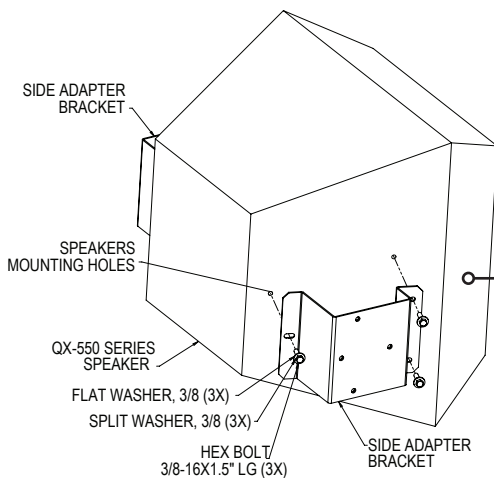

#### Installation Procedure:

##### Step 1:

Attach the side mounting brackets to the speaker using the provided hardware. Attach the two front round holes first, then the rear slotted holes. Tighten permanently.

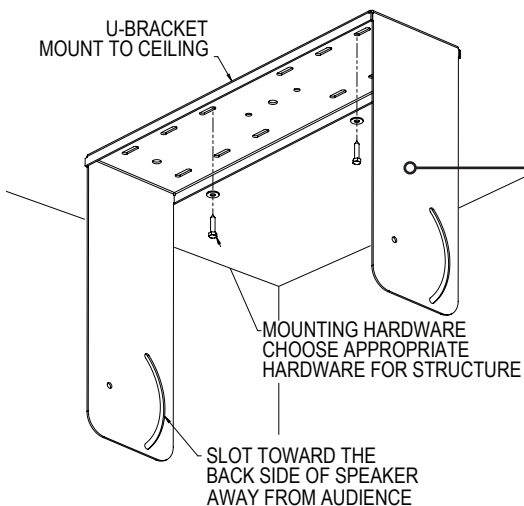

##### Step 2:

Attach the U-bracket to the wall, ceiling or deck using the appropriate hardware for the structure. Orient the U-bracket arm's long radius slot toward the back of the speaker, away from the audience

# Installation Guide

## UB-QX300

### 3 Piece U-Bracket Speaker Mount

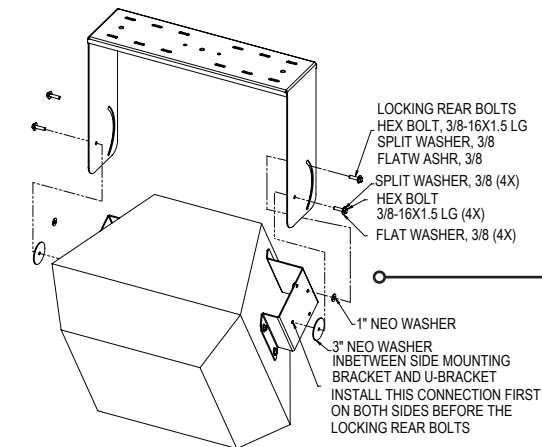

#### Step 3:

Insert the speaker with side brackets into the arms of the U-Bracket using the provided hardware. Do not tighten.

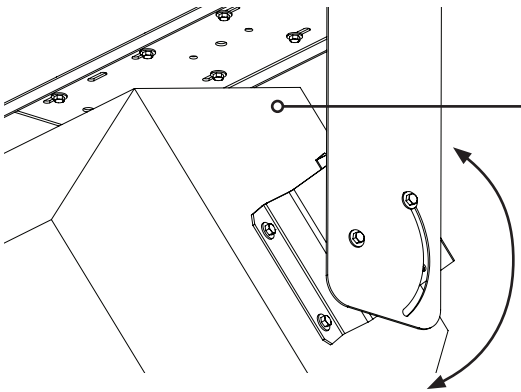

#### Step 4:

Set the desired tilt angle of the speaker and permanently tighten the side bolts.

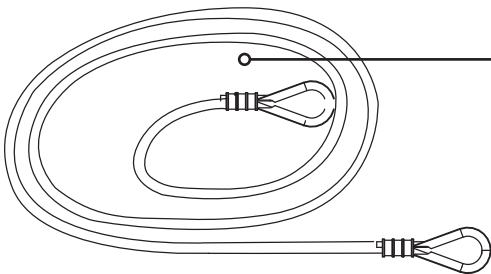

#### Step 5: Install Safety Cables

Install a safety cable directly to the speaker and to the structure, effectively bypassing the mounting system. Attachment to structure must be able to support 5 times the load of the speaker and bracket assembly

#### **Note to installers:**

Due to the wide variety of wall structures, materials and mounting methods, the installing contractor must exercise proper judgment in selecting the mounting area and hardware.

As a guide, the installation, when complete should be capable of supporting 5 to 10 times the actual applied load. Always use a backup safety system such as a safety cable.

To assure a trouble-free installation, read through and follow these instructions carefully before beginning. If you have doubts about the integrity of the structure you are mounting to or you are not sure about the proper hardware to use, consult a structural and/or hardware specialist.